



PRICE LIST 2015

ADIPO[®]

ULTRAFLEX[®]



A.E.M. srl di Rota & C.

Via Papa Giovanni XXIII, 7 - 41122 MODENA (Italy) - Tel. +39 059.25.05.64 - Fax +39 059.25.00.28
www.aemsrl.it - e-mail: info@aemsrl.it



A.E.M. S.r.l. Di Rota & C.
 41122 MODENA - (Italy)
 Via Papa Giovanni XXIII, 7
 Tel. 059.25.05.64 - Fax 059.25.00.28
 Sito Internet: www.aemsrl.it
 E-mail: Info@aemsrl.it

Reg. Soc. Tribunale di Modena n° 9174
 R.E.A. Di Modena n° 170278
 Cap. Soc. 50.000€ i.v.
 Cod. Fisc. e Partita I.V.A. N. 00507030369
 Codice Intra UE VAT nr. IT 00507030369

POLIURETANO COMPATTO DI QUALITÀ ADIPOL - ULTRAFLEX - POLIFLEX

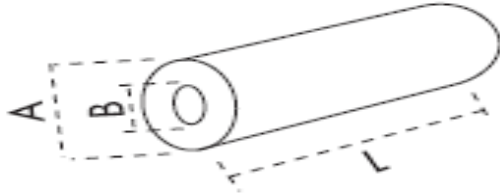

ADIPOL

- 70 Sh. A BLACK
- 80 Sh. A BLUE
- 90 Sh. A ORANGE
- 95 Sh. A HONEY

HOLLOW BARS FOR DIES

A mm	16	20	25	32	40	50	63	80	100	125
B mm	6,5	8,5	10,5	13,5	13,5	17	17	21	21	27
L mm	250	250	250	500	500	500	500	500	500	500
Price €	€ 4,43	€ 6,21	€ 9,77	€ 21,91	€ 37,02	€ 47,69	€ 74,64	€ 109,61	€ 178,92	€ 251,79

ULTRAFLEX

- 64 Sh. A YELLOW
- 82 Sh. A YELLOW
- 92 Sh. A RED
- 94 Sh. A GREEN

HOLLOW BARS FOR DIES

A mm	16	20	25	32	40	50	63	80	100	125
B mm	6,5	8,5	10,5	13,5	13,5	17	17	21	21	27
L mm	250	250	250	500	500	500	500	500	500	500
Price €	€ 7,71	€ 10,66	€ 16,58	€ 27,55	€ 45,03	€ 59,84	€ 90,65	€ 133,31	€ 225,13	€ 302,15





A.E.M. S.r.l. Di Rota & C.
 41122 MODENA - (Italy)
 Via Papa Giovanni XXIII, 7
 Tel. 059.25.05.64 - Fax 059.25.00.28
 Sito Internet: www.aemsrl.it
 E-mail: Info@aemsrl.it

Reg. Soc. Tribunale di Modena n° 9174
 R.E.A. Di Modena n° 170278
 Cap. Soc. 50.000€ i.v.
 Cod. Fisc. e Partita I.V.A. N. 00507030369
 Codice Intra UE VAT nr. IT 00507030369

POLIURETANO COMPATTO DI QUALITÀ ADIPOL - ULTRAFLEX - POLIFLEX

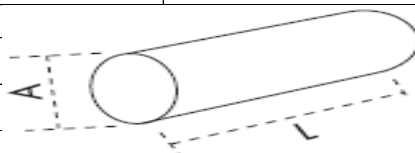

	70 Sh. A	BLACK		64 Sh. A	YELLOW
ADIPOL	80 Sh. A	BLUE	ULTRAFLEX	82 Sh. A	YELLOW
	90 Sh. A	ORANGE		92 Sh. A	RED
	95 Sh. A	HONEY		94 Sh. A	GREEN

MATERIAL SUPPLIED TO ORDER

SOLID BARS L=250 mm

Diameter	Code	ADIPOL	ULTRAFLEX	Minimum lot 10 Pieces
		Price €	Price €	
2	BP-2	3,56	4,44	
3	BP-3	3,56	4,44	
4	BP-4	3,56	4,44	
5	BP-5	3,56	4,44	
6	BP-6	3,70	4,74	
8	BP-8	3,91	5,04	
10	BP-10	4,68	5,62	
12	BP-12	5,04	6,21	
13	BP-13	5,21	6,51	
15	BP-15	6,51	8,00	
16	BP-16	7,10	8,59	
18	BP-18	9,49	11,54	
19	BP-19	10,07	12,15	
20	BP-20	10,66	13,02	
21	BP-21	11,86	14,21	
22	BP-22	13,63	16,58	
23	BP-23	13,63	16,58	
24	BP-24	15,43	17,78	
25	BP-25	16,00	19,25	



SOLID BARS L=500 mm

Diameter	Code	ADIPOL	ULTRAFLEX
		Price €	Price €
26	BP-26	22,52	26,66
28	BP-28	23,69	31,88
30	BP-30	25,47	30,80
30,5	BP-30,5	26,66	32,00
32	BP-32	27,84	33,78
35	BP-35	34,36	41,48
36	BP-36	37,32	45,62
37	BP-37	39,71	47,40
38	BP-38	42,06	50,36
40	BP-40	44,43	53,32
44	BP-44	45,62	55,10
45	BP-45	46,81	56,28
50	BP-50	57,47	69,32
51	BP-51	59,25	71,11
55	BP-55	70,50	84,72
60	BP-60	78,21	94,20
63	BP-63	85,89	103,09
65	BP-65	94,80	113,74
70	BP-70	103,68	124,42
74	BP-74	110,56	127,98
80	BP-80	122,06	134,49
90	BP-90	158,19	189,59
100	BP-100	197,89	242,90
105	BP-105	207,96	250,62
110	BP-110	214,48	257,72
120	BP-120	263,65	316,97
125	BP-125	270,16	324,68
130	BP-130	308,07	370,30
140	BP-140	337,71	405,84
150	BP-150	381,55	459,16
160	BP-160	435,46	524,33
200	BP-200	655,27	787,99
230	BP-230	958,23	1197,78
250	BP-250	1024,58	1264,26
260	BP-260	1219,86	1462,92





A.E.M. S.r.l. Di Rota & C.
41122 MODENA - (Italy)
Via Papa Giovanni XXIII, 7
Tel. 059.25.05.64 - Fax 059.25.00.28
Sito Internet: www.aemsrl.it
E-mail: Info@aemsrl.it

Reg. Soc. Tribunale di Modena n° 9174
R.E.A. Di Modena n° 170278
Cap. Soc. 50.000€ i.v.
Cod. Fisc. e Partita I.V.A. N. 00507030369
Codice Intra UE VAT nr. IT 00507030369

POLIURETANO COMPATTO DI QUALITÀ ADIPOL - ULTRAFLEX - POLIFLEX

ADIPOL	70 Sh. A	BLACK	ULTRAFLEX	64 Sh. A	YELLOW
	80 Sh. A	BLUE		82 Sh. A	YELLOW
	90 Sh. A	ORANGE		92 Sh. A	RED
	95 Sh. A	HONEY		94 Sh. A	GREEN

HOLLOW SPRINGS FOR DIES

code	<u>ADIPOL</u>	<u>ULTRAFLEX</u>
dia.16 x h - Hole 6,5	€Price	€Price
MF-16x3	1,05	1,05
MF-16x4	1,05	1,09
MF-16x5	1,05	1,09
MF-16x10	1,05	1,18
MF-16x12	1,07	1,30
MF-16x14,5	1,18	1,42
MF-16x15	1,24	1,54
MF-16x16	1,37	1,65
MF-16x20	1,42	1,72
MF-16x22	1,54	1,91
MF-16x24	1,54	1,91
MF-16x25	1,54	1,91
MF-16x30	1,72	2,03
MF-16x32	1,77	2,19
MF-16x38	2,84	3,44
MF-16x40	2,84	3,44

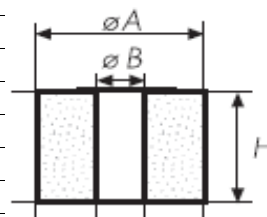

code	<u>ADIPOL</u>	<u>ULTRAFLEX</u>
dia.20 x h - Hole 8,5	€Price	€Price
MF-20x6	1,05	1,13
MF-20x12	1,42	1,77
MF-20x15	1,54	1,91
MF-20x16	1,54	1,91
MF-20x18	1,65	2,01
MF-20x20	1,65	2,01
MF-20x25	1,84	2,19
MF-20x26	1,84	2,19
MF-20x28	2,06	2,48
MF-20x30	2,06	2,48
MF-20x32	2,14	2,61



code	ADIPOL	ULTRAFLEX
dia.20 x h - Hole 8,5	€Price	€Price
MF-20x34	2,19	2,71
MF-20x40	2,30	2,85
MF-20X70	3,51	4,39
MF-20X80	3,51	4,39
code	ADIPOL	ULTRAFLEX
dia.25 x h - Hole 10,5	€Price	€Price
MF-25x10	1,49	1,84
MF-25x12	1,65	1,95
MF-25x13	1,78	2,06
MF-25x15	1,78	2,06
MF-25x16	1,84	2,19
MF-25x18	1,92	2,47
MF-25x20	2,01	2,61
MF-25x22	2,13	2,71
MF-25x23	2,13	2,71
MF-25x25	2,30	2,85
MF-25x26	2,30	2,85
MF-25x28	2,48	3,01
MF-25x32	2,79	3,32
MF-25x33	2,89	3,61
MF-25x35	3,15	3,73
MF-25x38	3,01	3,71
MF-25x40	3,08	3,85
MF-25x50	3,43	4,26
MF-25X63	5,45	6,50
code	ADIPOL	ULTRAFLEX
dia.32 x h - Hole 13,5	€Price	€Price
MF-32x4	1,07	1,18
MF-32x6	1,30	1,47
MF-32x12	1,42	1,65
MF-32x14	1,42	1,65
MF-32x15	1,47	1,77
MF-32x16	1,60	1,91
MF-32x20	1,77	2,25
MF-32x25	2,01	2,55
MF-32x30	2,24	2,71
MF-32x31	2,38	2,85
MF-32x32	2,38	2,85
MF-32x35	2,38	2,85
MF-32x36	2,48	2,96
MF-32x38	2,60	3,07
MF-32x40	2,66	3,13
MF-32x42,5	2,77	3,24
MF-32x45	2,84	3,36



code	ADIPOL	ULTRAFLEX
dia.32 x h - Hole 13,5	€Price	€Price
MF-32x47,5	2,96	3,53
MF-32x50	3,02	3,68
MF-32x53	3,02	3,68
MF-32x55	3,61	4,25
MF-32x56	3,61	4,25
MF-32x58	3,96	4,73
MF-32x60	3,96	4,73
MF-32x63	3,96	4,73
MF-32x64	3,96	4,73
MF-32x80	4,62	5,52
code	ADIPOL	ULTRAFLEX
dia.40 x h - Hole 13,5	€Price	€Price
MF-40x5	1,67	2,06
MF-40x15	2,15	2,55
MF-40x16	2,15	2,55
MF-40x18	2,29	2,66
MF-40x20	2,48	2,85
MF-40x25	2,85	3,49
MF-40x30	3,19	3,84
MF-40x32	3,32	4,10
MF-40x40	3,96	4,73
MF-40x42,5	4,13	4,95
MF-40x50	4,50	5,52
MF-40x51	4,50	5,52
MF-40x54	5,08	6,14
MF-40x55	5,08	6,14
MF-40x57	5,42	6,55
MF-40x60	5,78	7,08
MF-40x63	6,11	7,71
MF-40x65	6,49	8,13
MF-40x70	6,49	8,13
MF-40x80	7,10	8,51
MF-40x90	8,10	9,33
MF-40x115	8,52	10,36
code	ADIPOL	ULTRAFLEX
dia.50 x h - Hole 17	€Price	€Price
MF-50x5	1,89	2,29
MF-50x10	2,37	2,71
MF-50x11	2,66	3,07
MF-50x16	2,96	3,53
MF-50x17	2,96	3,53
MF-50x20	3,43	4,08
MF-50x25	3,85	4,73
MF-50x32	4,44	5,62
MF-50x40	5,33	6,21



dia.50 x h - Hole 17		€Price	€Price
MF-50x43		5,33	6,21
MF-50x44		5,78	6,97
MF-50x45		5,78	6,97
MF-50x46		5,90	7,08
MF-50x50		6,21	7,71
MF-50x51		6,21	7,71
MF-50x52		6,72	8,26
MF-50x53		6,72	8,26
MF-50x54		6,72	8,26
MF-50x55		6,84	8,55
MF-50x56		6,84	8,55
MF-50x60		7,55	9,43
MF-50x62		8,29	9,77
MF-50x63		8,29	9,77
MF-50x68		8,73	10,32
MF-50x70		8,73	10,32
MF-50x80		9,49	11,26
MF-50x89		11,86	14,21
MF-50x100		11,86	14,21
MF-50x150		18,08	24,74
code		ADIPOL	ULTRAFLEX
dia.63 x h - Hole 17		€Price	€Price
MF-63x32		6,51	7,71
MF-63x39		7,71	9,77
MF-63x40		7,71	9,77
MF-63x42		7,71	9,77
MF-63x45		8,88	11,26
MF-63x50		8,88	11,26
MF-63x56		10,38	12,60
MF-63x60		10,68	12,81
MF-63x63		11,86	13,92
MF-63x75		14,47	17,04
MF-63x80		13,92	17,18
MF-63x95		16,30	20,14
MF-63x100		16,30	20,14
MF63x103		17,10	21,23
MF-63x105		17,10	21,23
MF-63x110		17,98	22,40
MF-63x115		18,97	23,58
MF-63x125		20,14	24,88
MF-63x210		33,74	39,18
code		ADIPOL	ULTRAFLEX
dia.80 x h - Hole 21		€Price	€Price



MF-80x29	8,85	10,32
MF-80x32	9,49	11,54
MF-80x40	11,25	13,92
MF-80x44	12,74	13,94
MF-80x50	12,74	15,10
MF-80x53	13,85	17,10
MF-80x63	17,77	23,10
MF-80x80	20,14	24,88
MF-80x100	23,69	29,03
MF-80x110	26,24	32,00
MF-80x113	26,24	32,00
MF-80x120	29,03	33,17
MF-80x125	29,03	33,17
MF-80x132	36,43	41,65
MF-80x134	36,43	41,65
MF-80x151	36,43	41,65
MF-80x160	38,51	45,32

code	<u>ADIPOL</u>	<u>ULTRAFLEX</u>
dia.100xh - Hole 21	€Price	€Price
MF-100x20	12,68	15,32
MF-100x25	12,68	15,32
MF-100x27	14,53	17,18
MF-100x32	14,53	17,18
MF-100x40	17,77	20,14
MF-100x47	20,74	24,30
MF-100x50	20,74	24,30
MF-100x63	28,45	33,17
MF-100x68	32,59	39,71
MF-100x75	32,59	39,71
MF-100x80	32,59	39,71
MF-100x82	32,59	39,71
MF-100x90	36,54	43,62
MF-100x100	37,62	45,04
MF-100x105	44,20	53,05
MF-100X110	45,00	54,65
MF-100x125	47,15	56,58
MF-100x130	51,87	63,07
MF-100X150	57,15	68,04
MF-100x160	62,21	78,50
MF-100x165	67,98	81,92
MF-100X170	67,98	81,92
MF-100X190	72,92	87,06



code	<u>ADIPOL</u>	<u>ULTRAFLEX</u>
dia.125xh - Hole 27	€Price	€Price

MF-125x32	19,55	24,59
MF-125x40	23,41	29,03
MF-125x45	25,35	30,65
MF-125x50	27,83	33,17
MF-125x60	37,62	45,32
MF-125x63	37,62	45,32
MF-125x70	38,91	48,33
MF-125x80	44,43	53,38
MF-125x100	52,14	62,81
MF-125x125	63,98	78,50
MF-125x160	84,72	106,64
MF-125x200	109,62	151,08





A.E.M. S.r.l. Di Rota & C.
41122 MODENA - (Italy)
Via Papa Giovanni XXIII, 7
Tel. 059.25.05.64 - Fax 059.25.00.28
Sito Internet: www.aemsrl.it
E-mail: Info@aemsrl.it

Reg. Soc. Tribunale di Modena n° 9174
R.E.A. Di Modena n° 170278
Cap. Soc. 50.000€ i.v.
Cod. Fisc. e Partita I.V.A. N. 00507030369
Codice Intra UE VAT nr. IT 00507030369

POLIURETANO COMPATTO DI QUALITÀ ADIPOL - ULTRAFLEX - POLIFLEX

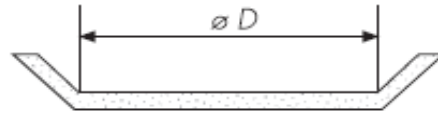

METAL SEATS - SPRING PARTITIONS

CODE	000-SE-20	000-SE-25	000-SE-32	000-SE-40	000-SE-50	000-SE-63	000-SE-80	000-SE-100
D	20	25	32	40	50	63	80	100
Price €	€ 0,84	€ 0,88	€ 0,95	€ 1,01	€ 1,12	€ 1,24	€ 3,20	€ 3,52

Sold in packages of 10 pieces





A.E.M. S.r.l. Di Rota & C.
41122 MODENA - (Italy)
Via Papa Giovanni XXIII, 7
Tel. 059.25.05.64 - Fax 059.25.00.28
Sito Internet: www.aemsrl.it
E-mail: Info@aemsrl.it

Reg. Soc. Tribunale di Modena n° 9174
R.E.A. Di Modena n° 170278
Cap. Soc. 50.000€ i.v.
Cod. Fisc. e Partita I.V.A. N. 00507030369
Codice Intra UE VAT nr. IT 00507030369

POLIURETANO COMPATTO DI QUALITÀ ADIPOL - ULTRAFLEX - POLIFLEX

CYLINDRICAL PUSH-RODS

CODE	U92-PU-2x15	U92-PU-3x15	U92-PU-4,5x15	U92-PU-6x20
D mm	2	3	4,5	6
H mm	15	15	15	20
Price €	€ 0,53	€ 0,59	€ 0,65	€ 0,82

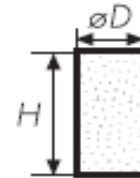

Sold in packages of 10 pieces

CONE-SHAPED PUSH-RODS

CODE	U92-PU-6x10	U92-PU-10x15	U92-PU-16x25	U92-PU-24x25	U92-PU-40x40
D mm	6	10	16	24	40
H mm	10	15	25	25	40
Price €	€ 0,88	€ 1,18	€ 1,76	€ 2,95	€ 8,87

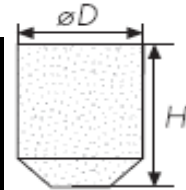

Sold in packages of 10 pieces





A.E.M. S.r.l. Di Rota & C.
 41122 MODENA - (Italy)
 Via Papa Giovanni XXIII, 7
 Tel. 059.25.05.64 - Fax 059.25.00.28
 Sito Internet: www.aemsrl.it
 E-mail: Info@aemsrl.it

Reg. Soc. Tribunale di Modena n° 9174
 R.E.A. Di Modena n° 170278
 Cap. Soc. 50.000€ i.v.
 Cod. Fisc. e Partita I.V.A. N. 00507030369
 Codice Intra UE VAT nr. IT 00507030369

POLIURETANO COMPATTO DI QUALITÀ ADIPOL - ULTRAFLEX - POLIFLEX

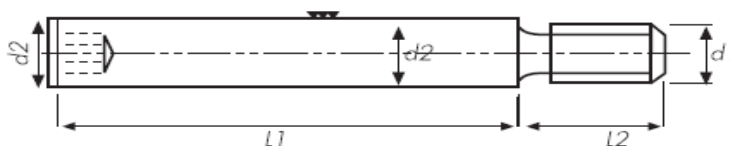

PILOT PINS FOR ELASTOMER SPRINGS

Hexagon	3	4	5	6	8	10	14
L2	6	9	15	15	18	25	30
d1	M4	M6	M8	M10	M12	M16	M20
d2	6	8	10	13	16	20	25
L1	Lenght Tolerance L1 +0/+0,1 mm						
	Price €	Price €	Price €	Price €	Price €	Price €	Price €
15	€ 2,01	€ 2,12	€ 2,65	€ 3,33			
20	€ 2,01	€ 2,12	€ 2,65	€ 3,33	€ 4,18		
25	€ 2,01	€ 2,12	€ 2,65	€ 3,33	€ 4,18	€ 6,60	
32	€ 2,06	€ 2,24	€ 2,81	€ 3,33	€ 4,41	€ 6,60	€ 14,50
40	€ 2,35	€ 2,51	€ 2,97	€ 3,43	€ 4,77	€ 7,16	€ 14,50
50	€ 2,87	€ 2,81	€ 3,33	€ 3,73	€ 5,21	€ 7,51	€ 15,83
63		€ 3,50	€ 3,66	€ 4,05	€ 5,51	€ 8,32	€ 17,15
95			€ 5,28	€ 4,59	€ 6,42	€ 9,92	€ 21,79
118				€ 5,57	€ 6,93	€ 11,25	€ 22,84
140					€ 8,10	€ 13,19	€ 24,03
180					€ 10,54	€ 17,15	€ 26,39
200						€ 19,79	€ 29,72

Sold in packages of 10 pieces





A.E.M. S.r.l. Di Rota & C.
 41122 MODENA - (Italy)
 Via Papa Giovanni XXIII, 7
 Tel. 059.25.05.64 - Fax 059.25.00.28
 Sito Internet: www.aemsrl.it
 E-mail: Info@aemsrl.it

Reg. Soc. Tribunale di Modena n° 9174
 R.E.A. Di Modena n° 170278
 Cap. Soc. 50.000€ i.v.
 Cod. Fisc. e Partita I.V.A. N. 00507030369
 Codice Intra UE VAT nr. IT 00507030369

POLIURETANO COMPATTO DI QUALITÀ ADIPOL - ULTRAFLEX - POLIFLEX

CODE	A	B	Price €
	mm		
U92C0488	25	45	€ 7,57
U92C0489	32	50	€ 9,66
U92C0490	40	60	€ 12,40
U92C0491	50	70	€ 15,58
U92C0492	63	80	€ 21,06
U92C0493	80	90	€ 38,19

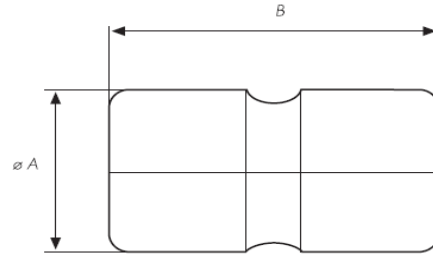

STRIPPER

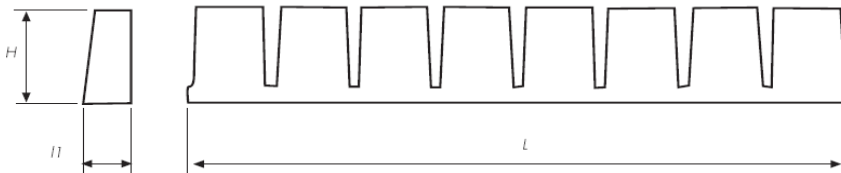

CODE	NUMBERS ELEMENTS	LENGHT	HEIGHT	LARGE	Price €
P70C0515	9	306	27	19	€ 32,92
A80C0515	9	310	35	19	€ 34,02
U92C0959	8	400	65	32	€ 64,08

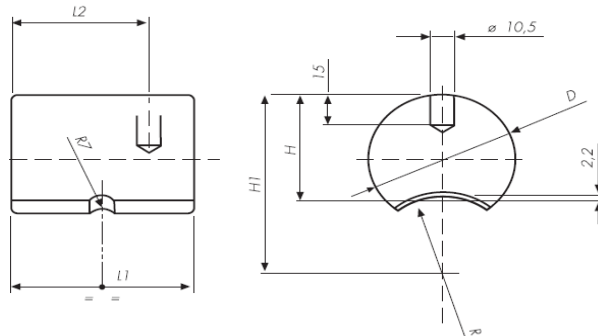

DAMPER

CODE	D	H	H1	L1	L2	R	Price €
U92C0992	40	32	50	60	45	18	€ 15,91
U92C0993	50	40	63	80	60	23	€ 22,27
U92C0994	63	51	86	80	60	35	€ 34,02





A.E.M. S.r.l. Di Rota & C.
 41122 MODENA - (Italy)
 Via Papa Giovanni XXIII, 7
 Tel. 059.25.05.64 - Fax 059.25.00.28
 Sito Internet: www.aemsrl.it
 E-mail: Info@aemsrl.it

Reg. Soc. Tribunale di Modena n° 9174
 R.E.A. Di Modena n° 170278
 Cap. Soc. 50.000€ i.v.
 Cod. Fisc. e Partita I.V.A. N. 00507030369
 Codice Intra UE VAT nr. IT 00507030369

POLIURETANO COMPATTO DI QUALITÀ ADIPOL - ULTRAFLEX - POLIFLEX

PAD FOR FORMING PRESS

SOLID PADS		L=835 mm	
Code	A	B	Price €
U92-LI-25x25x835	25	25	€ 47,37
U92-LI-50x50x835	50	50	€ 144,56
U92-LI-50x75x835	50	75	€ 225,13
U92-LI-50x100x835	50	100	€ 248,84

HOLLOW PADS		L=835 mm	
Code	A	B	Price €
U92-LF-25x25x835	25	25	€ 59,24
U92-LF-50x50x835	50	50	€ 181,30
U92-LF-50x75x835	50	75	€ 291,48
U92-LF-50x100x835	50	100	€ 373,25

TRIANGULAR PAD		L=835 mm	
Code		B	Price €
U92-LT-35x50x835			€ 71,10

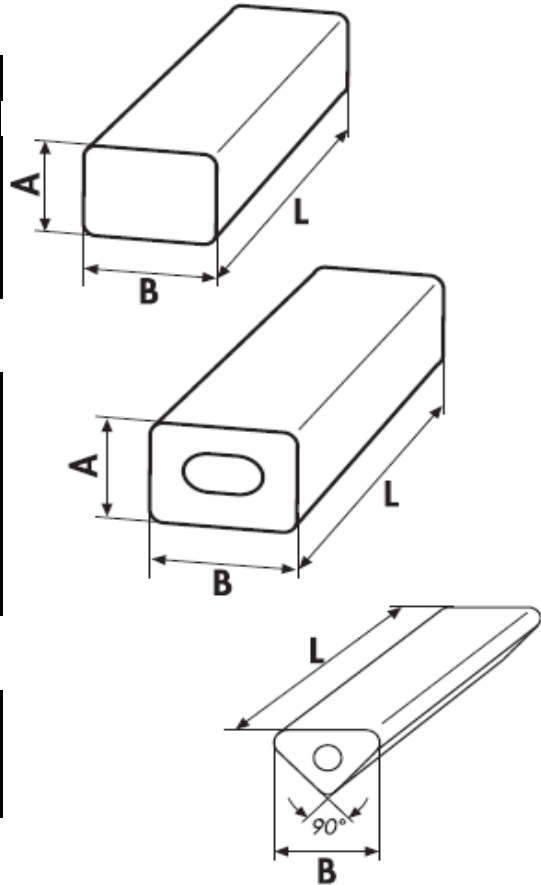



A.E.M. S.r.l. Di Rota & C.
41122 MODENA - (Italy)
Via Papa Giovanni XXIII, 7
Tel. 059.25.05.64 - Fax 059.25.00.28
Sito Internet: www.aemsrl.it
E-mail: Info@aemsrl.it

Reg. Soc. Tribunale di Modena n° 9174
R.E.A. Di Modena n° 170278
Cap. Soc. 50.000€ i.v.
Cod. Fisc. e Partita I.V.A. N. 00507030369
Codice Intra UE VAT nr. IT 00507030369

POLIURETANO COMPATTO DI QUALITÀ ADIPOL - ULTRAFLEX - POLIFLEX

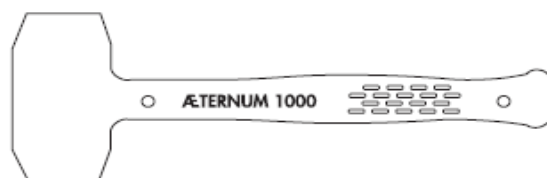

NO-REBOUND AETERNUM

CODE	Weight gr.	Price €
U92-MZ-600	600	€ 18,59
U92-MZ-1000	1000	€ 24,26
U92-MZ-1500	1500	€ 29,02





A.E.M. S.r.l. Di Rota & C.
 41122 MODENA - (Italy)
 Via Papa Giovanni XXIII, 7
 Tel. 059.25.05.64 - Fax 059.25.00.28
 Sito Internet: www.aemsrl.it
 E-mail: Info@aemsrl.it

Reg. Soc. Tribunale di Modena n° 9174
 R.E.A. Di Modena n° 170278
 Cap. Soc. 50.000€ i.v.
 Cod. Fisc. e Partita I.V.A. N. 00507030369
 Codice Intra UE VAT nr. IT 00507030369

POLIURETANO COMPATTO DI QUALITÀ ADIPOL - ULTRAFLEX - POLIFLEX

	70 Sh. A	BLACK		64 Sh. A	YELLOW
ADIPOL	80 Sh. A	BLUE	ULTRAFLEX	82 Sh. A	YELLOW
	90 Sh. A	ORANGE		92 Sh. A	RED
	95 Sh. A	HONEY			

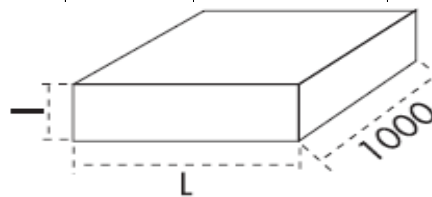

STRIPS LENGHT 1000 mm

<u>ADIPOL</u>		<u>ULTRAFLEX</u>	
Code - mm	Price €	Code - mm	Price €
A90LI 10x10	13,27	U92LI 10x10	14,81
A90LI 10x15	20,15	U92LI 10x15	22,52
A90LI 10x20	26,55	U92LI 10x20	30,22
A90LI 10x25	29,04	U92LI 10x25	32,00
A90LI 10x30	32,23	U92LI 10x30	35,56
A90LI 10x35	37,93	U92LI 10x35	42,08
A90LI 10x40	42,66	U92LI 10x40	47,99
A90LI 10x45	48,59	U92LI 10x45	54,00
A90LI 10x50	53,09	U92LI 10x50	59,84
A90LI 10x55	58,67	U92LI 10x55	66,36
A90LI 10x60	63,99	U92LI 10x60	72,28
A90LI 10x70	66,95	U92LI 10x70	75,84
A90LI 10x80	71,10	U92LI 10x80	80,57
A90LI 10x90	79,98	U92LI 10x90	90,05
A90LI 10x100	88,16	U92LI 10x100	100,14
A90LI 10x120	106,64	U92LI 10x120	120,00
A90LI 10x150	125,61	U92LI 10x150	142,20
A90LI 10x190	167,08	U92LI 10x190	167,08
A90LI 10x200	167,08	U92LI 10x200	167,08
A90LI 10x250	190,19	U92LI 10x250	215,65
A90LI 12X100	111,35	U92LI 12X100	125,14
A90LI 15x15	30,22	U92LI 15x15	33,78





A.E.M. S.r.l. Di Rota & C.
 41122 MODENA - (Italy)
 Via Papa Giovanni XXIII, 7
 Tel. 059.25.05.64 - Fax 059.25.00.28
 Sito Internet: www.aemsrl.it
 E-mail: Info@aemsrl.it

Reg. Soc. Tribunale di Modena n° 9174
 R.E.A. Di Modena n° 170278
 Cap. Soc. 50.000€ i.v.
 Cod. Fisc. e Partita I.V.A. N. 00507030369
 Codice Intra UE VAT nr. IT 00507030369

POLIURETANO COMPATTO DI QUALITÀ ADIPOL - ULTRAFLEX - POLIFLEX

ADIPOL	70 Sh. A	BLACK	ULTRAFLEX	64 Sh. A YELLOW
	80 Sh. A	BLUE		82 Sh. A YELLOW
	90 Sh. A	ORANGE		92 Sh. A RED
	95 Sh. A	HONEY		

SLABS

CENTRIFUGED SLABS 500x2000 mm		<u>ADIPOL</u>	<u>ULTRAFLEX</u>
Sp. mm		price €	price €
1		71,10	82,94
1,5		88,89	103,68
2		88,89	103,68
3		130,34	151,08
4		165,88	189,59
5		188,41	225,14
6		226,32	266,60
8		295,04	349,56
10		370,30	438,42

CAST SLABS 1000x1000 mm		<u>ADIPOL</u>	<u>ULTRAFLEX</u>
Sp. mm		price €	price €
10		364,35	432,50
12		439,62	521,36
15		546,26	651,72
20		755,40	888,70
25		942,01	1.125,69
30		1.130,42	1.344,75
35		1.318,24	1.570,03
40		1.507,23	1.798,14
50		1.884,04	2.251,37





A.E.M. S.r.l. Di Rota & C.
 41122 MODENA - (Italy)
 Via Papa Giovanni XXIII, 7
 Tel. 059.25.05.64 - Fax 059.25.00.28
 Sito Internet: www.aemsrl.it
 E-mail: Info@aemsrl.it

Reg. Soc. Tribunale di Modena n° 9174
 R.E.A. Di Modena n° 170278
 Cap. Soc. 50.000€ i.v.
 Cod. Fisc. e Partita I.V.A. N. 00507030369
 Codice Intra UE VAT nr. IT 00507030369

POLIURETANO COMPATTO DI QUALITÀ ADIPOL - ULTRAFLEX - POLIFLEX

ADIPOL	70 Sh. A	BLACK	ULTRAFLEX	64 Sh. A	YELLOW
	80 Sh. A	BLUE		82 Sh. A	YELLOW
	90 Sh. A	ORANGE		92 Sh. A	RED
	95 Sh. A	HONEY			

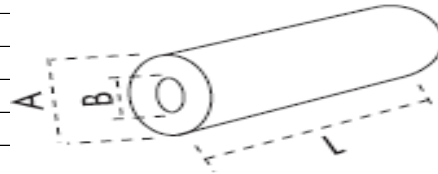

SLEEVES LENGTH 250 mm

Diameter	Codice	ADIPOL	ULTRAFLEX
		Price €	Price €
MINIMUM LOT 10 PCS.			
11x6,5	MA-11X6,5	4,44	5,21
11x7	MA-11X7	4,44	5,21
12x6,5	MA-12X6,5	5,33	5,33
13x5	MA-13X5	5,69	6,82
13x6,5	MA-13X6,5	5,52	6,63
13x8	MA-13X8	4,73	5,52
15x7	MA-15X7	4,57	7,00
16x9	MA-16X9	5,52	6,82
16x10	MA-16X10	4,97	6,63
16x10,5	MA-16X10,5	4,87	5,93
16x11	MA-16X11	4,73	5,21
16x12	MA-16X12	4,33	5,21
16x13	MA-16x13	4,33	5,21
16x13,5	MA-16X13,5	4,15	5,10
16,5x10	MA-16,5X10	5,93	6,82
16,5x11	MA-16,5X11	5,34	5,93



MANICOTTI LUNGHEZZA 500 mm				
Diameter	Code	ADIPOL		ULTRAFLEX
		Price €		Price €
MINIMUM LOT 10 PCS.				
28x10,5	MA-28x10,5	32,00		37,33
28x11	MA-28x11	31,27		36,73
28x15	MA-28x15	29,39		34,95
28x16	MA-28x16	27,26		33,18
28x18	MA-28x18	24,89		29,64
28x20	MA-28x20	20,86		25,01
28x22	MA-28x22	17,06		20,44
30x10	MA-30x10	32,60		41,48
30x11	MA-30x11	30,80		36,73
30x12	MA-30x12	29,04		34,96
30x13	MA-30x13	27,26		33,78
30x13,5	MA-30x13,5	26,97		33,18
30x14	MA-30x14	26,08		32,60
30x15	MA-30x15	24,88		29,61
30x16	MA-30x16	23,70		27,85
30x17	MA-30x17	21,92		27,25
30x18	MA-30x18	21,04		25,48
30x19	MA30X19	20,74		24,88
30x20	MA-30x20	20,14		24,30
30x23	MA-30x23	17,18		21,32
30x24	MA-30x24	14,21		17,77
30x25	MA-30x25	11,86		15,41
32x10,5	MA-32x10,5	31,40		37,91
32x11	MA-32x11	29,64		37,33
32x12	MA-32x12	28,45		34,07
32x13	MA-32x13	26,66		30,22
32x15	MA-32x15	22,58		27,14
32x16	MA-32x16	21,97		26,36
32x17	MA-32x17	21,04		25,66
32x18	MA-32x18	20,14		24,11
32x20	MA-32x20	18,25		21,92
32x23	MA-32x23	16,35		19,55
32x24	MA-32x24	15,10		18,08
32x25	MA-32x25	14,53		17,35
35x11	MA-35x11	32,65		39,57
35x12	MA-35x12	41,91		37,69
35x13	MA-35x13	30,22		36,44
35x13,5	MA-35x13,5	29,03		35,25
35x15	MA-35x15	28,26		33,94
35x16	MA-35x16	26,79		33,18
35x17	MA-35x17	26,13		32,00
35x18	MA-35x18	25,12		30,22
35x20	MA-35x20	28,26		29,61
35x23	MA-35x23	22,63		27,25
35x24	MA-35x24	20,74		25,47
PRICE LIST 2015				PAG. 24

Diameter	Code	ADIPOL Price €	ULTRAFLEX Price €
MINIMUM LOT 10 PCS.			
35x25	MA-35x25	18,83	23,10
35x26	MA-35x26	18,25	22,52
35x27	MA-35x27	17,60	21,92
35x28	MA-35x28	17,18	21,92
35x30	MA-35x30	14,81	17,18
36x15	MA-36x15	28,26	33,94
37x14	MA-37x14	34,54	42,66
37x15	MA-37x15	33,66	41,48
37x16	MA-37x16	32,89	40,88
37x17	MA-37x17	32,05	40,28
37x30	MA-37x30	18,83	23,69
38x10,5	MA-38x10,5	36,44	44,15
38x13,5	MA-38x13,5	35,25	42,66
38x15	MA-38x15	34,54	41,48
38x16	MA-38x16	33,90	40,89
38x17	MA-38x17	33,31	40,28
38x18	MA-38x18	32,00	39,71
38x20	MA-38x20	30,22	36,44
38x25	MA-38x25	23,88	29,03
38x28	MA-38x28	21,97	26,66
38x29,5	MA-38x29,5	20,15	25,48
38x30	MA-38x30	19,49	23,99
40x10,5	MA-40x10,5	40,89	53,33
40x11,5	MA-40x11,5	39,71	47,52
40x13	MA-40x13	37,63	45,63
40x13,5	MA-40x13,5	37,04	45,04
40x15	MA-40x15	39,74	43,25
40x16	MA-40x16	35,90	49,19
40x17	MA-40x17	35,19	47,40
40x18	MA-40x18	34,53	44,43
40x19	MA-40x19	33,60	41,48
40x20	MA-40x20	32,70	39,10
40x21	MA-40x21	32,00	38,51
40x22	MA-40x22	30,80	37,03
40x23	MA-40x23	29,61	35,56
40x24	MA-40x24	28,32	34,96
40x25	MA-40x25	27,02	32,00
40x26	MA-40x26	26,42	31,41
40x27	MA-40x27	25,78	31,40
40x28	MA-40x28	24,89	30,22
40x30	MA-40x30	23,88	28,73
40x31,5	MA-40x31,5	23,35	27,85
40x32	MA-40x32	22,63	27,14
45x10	MA-45x10	48,35	58,66
45x11	MA-45x11	48,35	58,66
45x11,5	MA-45x11,5	47,40	57,48
PRICE LIST 2015			
PAG. 25			

Diameter	Code	ADIPOL Price €	ULTRAFLEX Price €
MINIMUM LOT 10 PCS.			
45x13,5	MA-45x13,5	46,57	56,30
45x14	MA-45x14	45,85	55,10
45x15	MA-45x15	45,85	55,10
45x16	MA-45x16	45,33	54,52
45x17	MA-45x17	44,62	53,91
45x18	MA-45x18	44,08	51,55
45x20	MA-45x20	43,37	49,76
45x21	MA-45x21	42,08	45,63
45x22	MA-45x22	40,89	44,44
45x24	MA-45x24	38,87	42,08
45x25	MA-45x25	37,67	45,04
45x27	MA-45x27	34,54	37,91
45x29	MA-45x29	30,80	33,31
45x30	MA-45x30	30,80	33,31
45x32	MA-45x32	24,53	36,14
45x35	MA-45x35	24,53	29,33
MINIMUM LOT 5 PCS.			
50x10	MA-50x10	60,90	73,46
50x14	MA-50x14	60,90	73,46
50x15	MA-50x15	47,71	59,84
50x16	MA-50x16	47,71	59,84
50x17	MA-50x17	47,71	59,84
50x18	MA-50x18	50,25	59,84
50x19	MA-50x19	49,00	58,66
50x20	MA-50x20	47,71	56,87
50x21	MA-50x21	46,81	56,30
50x22	MA-50x22	45,85	55,10
50x24	MA-50x24	45,14	54,52
50x25	MA-50x25	44,62	51,54
50x26	MA-50x26	44,08	52,74
50x27	MA-50x27	43,37	52,14
50x28	MA-50x28	42,42	51,55
50x29	MA-50x29	41,48	50,36
50x30	MA-50x30	41,48	50,36
50x30,5	MA-50x30,5	40,89	48,59
50x32	MA-50x32	39,10	47,39
50x33	MA-50x33	39,10	47,39
50x35	MA-50x35	35,56	42,66
50x36	MA-50x36	34,08	41,48
50x37	MA-50x37	32,60	40,29
50x38	MA-50x38	31,40	37,91
50x39,5	MA-50x39,5	24,30	33,78
50x40	MA-50x40	25,78	31,40
55x17	MA-55x17	65,93	82,94
55x18	MA-55x18	64,59	81,76
55x20	MA-55x20	62,21	74,65
55x21	MA-55x21	61,62	72,52
55x24	MA-55x24	57,48	71,69
55x25	MA-55x25	56,28	68,13
PRICE LIST 2015			
PAG. 26			

Diameter	Code	ADIPOL Price €	ULTRAFLEX Price €
MINIMUM LOT 5 PCS.			
55x26	MA-55x26	55,11	66,95
55x27	MA-55x27	53,38	63,98
55x28	MA-55x28	53,38	63,98
55x30	MA-55x30	50,84	62,81
55x30,5	MA-55x30,5	50,37	61,03
55x31,5	MA-55x31,5	50,24	60,43
55x35	MA-55x35	46,51	56,28
55x36	MA-55x36	44,44	52,74
55x38	MA-55x38	40,82	48,59
55x40	MA-55x40	39,71	47,39
55x43	MA-55x43	32,70	39,69
60x13,5	MA-60x13,5	81,64	97,76
60x17	MA-60x17	74,06	87,68
60x18	MA-60x18	72,87	86,50
60x20	MA-60x20	71,69	85,89
60x21	MA-60x21	70,50	84,72
60x22	MA-60x22	68,73	82,94
60x23	MA-60x23	68,73	82,94
60x24	MA-60x24	67,83	81,76
60x25	MA-60x25	66,95	79,98
60x26	MA-60x26	65,18	78,80
60x27	MA-60x27	63,99	77,61
60x28	MA-60x28	62,81	75,25
60x29,5	MA-60x29,5	61,63	74,06
60x30	MA-60x30	60,43	72,86
60x31	MA-60x31	59,14	70,50
60x32	MA-60x32	56,53	68,13
60x35	MA-60x35	54,80	66,35
60x36	MA-60x36	52,74	63,40
60x37	MA-60x37	50,71	61,02
60x38	MA-60x38	49,19	59,75
60x39,5	MA-60x39,5	47,40	57,48
60x40	MA-60x40	45,85	59,49
60x43	MA-60x43	43,96	52,73
60x48	MA-60x48	38,39	49,16
60x50	MA-60x50	36,44	44,43
63x13,5	MA-63x13,5	87,98	105,46
63x17	MA-63x17	74,65	90,65
63x18	MA-63x18	79,98	94,20
63x20	MA-63x20	77,91	93,01
63x21	MA-63x21	76,19	91,84
63x22	MA-63x22	74,06	88,28
63x25	MA-63x25	72,86	87,68
63x26	MA-63x26	72,28	87,09
63x28	MA-63x28	71,10	86,50
63x29,5	MA-63x29,5	70,80	85,91
63x30	MA-63x30	70,50	85,89
63x32	MA-63x32	69,32	81,76
PRICE LIST 2015			
PAG. 27			

Diameter	Code	ADIPOL Price €	ULTRAFLEX Price €
MINIMUM LOT 5 PCS.			
63x35	MA-63x35	67,54	79,40
63x36	MA-63x36	66,35	77,61
63x37	MA-63x37	64,59	77,02
63x38	MA-63x38	62,81	75,25
63x39,5	MA-63x39,5	59,67	71,69
63x40	MA-63x40	56,28	66,95
63x45	MA-63x45	49,18	59,25
65x55	MA-65x55	45,44	49,25
70x17	MA-70x17	97,76	114,94
70x20	MA-70x20	97,76	114,94
70x21	MA-70x21	95,39	114,35
70x24	MA-70x24	93,61	111,28
70x25	MA-70x25	91,84	110,19
70x26	MA-70x26	90,05	107,83
70x28	MA-70x28	88,28	104,87
70x29,5	MA-70x29,5	86,80	101,91
70x30	MA-70x30	85,32	102,48
70x31	MA-70x31	83,54	99,53
70x35	MA-70x35	77,02	95,99
70x38	MA-70x38	74,06	88,28
70x40	MA-70x40	71,69	85,89
70x45	MA-70x45	63,98	77,02
70x49	MA-70x49	56,30	67,54
70x50	MA-70x50	54,51	65,77
70x55	MA-70x55	45,04	52,74
70x56	MA-70x56	41,48	50,36
70x60	MA-70x60	39,40	46,81
MINIMUM LOT 2 PCS.			
80x17	MA-80x17	130,94	141,01
80x20	MA-80x20	130,94	141,01
80x20,5	MA-80x20,5	130,35	141,01
80x24	MA-80x24	121,46	130,35
80x25	MA-80x25	119,09	130,34
80x25,5	MA-80x25,5	119,09	130,35
80x26	MA-80x26	117,91	129,75
80x27	MA-80x27	116,72	128,56
80x29	MA-80x29	116,12	127,38
80x30	MA-80x30	115,53	126,78
80x31	MA-80x31	114,94	126,20
80x32	MA-80x32	114,35	125,61
80x35	MA-80x35	110,79	121,45
80x36	MA-80x36	110,19	120,86
80x39	MA-80x39	103,68	111,39
80x40	MA-80x40	103,09	112,58
80x41	MA-80x41	102,50	112,58
80x42	MA-80x42	101,91	111,39
80x42,5	MA-80x42,5	101,31	110,79
PRICE LIST 2015			PAG. 28

Diameter	Code	ADIPOL Price €	ULTRAFLEX Price €
MINIMUM LOT 2 PCS.			
80x44	MA-80x44	100,71	110,19
80x45	MA-80x45	100,72	110,20
80x46	MA-80x46	100,13	109,61
80x48,5	MA-80x48,5	91,24	100,72
80x49,5	MA-80x49,5	88,28	96,57
80x50	MA-80x50	83,54	92,43
80x51	MA-80x51	82,94	91,84
80x55	MA-80x55	81,76	90,05
80x56	MA-80x56	80,57	88,87
80x58	MA-80x58	74,06	84,72
80x59	MA-80x59	72,28	79,98
80x60	MA-80x60	62,81	68,73
80x64	MA-80x64	58,66	64,58
80x65	MA-80x65	56,30	61,03
80x70	MA-80x70	41,48	45,62
90x19	MA-90x19	154,05	178,34
90x20	MA-90x20	150,49	174,19
90x21	MA-90x21	147,52	169,44
90x25	MA-90x25	142,72	167,67
90x30	MA-90x30	138,23	165,88
90x32	MA-90x32	135,68	164,71
90x35	MA-90x35	130,35	159,97
90x36	MA-90x36	129,17	157,01
90x40	MA-90x40	126,20	151,68
90x45	MA-90x45	122,06	146,34
90x49	MA-90x49	115,54	131,53
90x50	MA-90x50	117,30	128,56
90x59	MA-90x59	94,80	117,31
90x60	MA-90x60	97,76	115,53
90x65	MA-90x65	89,17	106,64
90x70	MA-90x70	77,02	90,05
90x75	MA-90x75	62,81	75,25
100x20	MA-100x20	201,44	243,51
100x25	MA-100x25	196,71	236,39
100x27	MA-100x27	194,67	234,03
100x29	MA-100x29	193,45	231,65
100x30	MA-100x30	191,07	220,87
100x31	MA-100x31	184,32	243,59
100x34	MA-100x34	174,78	202,14
100x35	MA-100x35	169,56	196,14
100x39	MA-100x39	160,79	187,21
100x40	MA-100x40	160,79	187,21
100x45	MA-100x45	153,87	184,85
100x50	MA-100x50	145,09	174,19
100x55	MA-100x55	135,03	163,52
100x56	MA-100x56	133,72	161,74
100x60	MA-100x60	123,22	147,52
100x65	MA-100x65	122,06	145,74
PRICE LIST 2015			
PAG. 29			

Diameter	Code	ADIPOL Price €	ULTRAFLEX Price €
MINIMUM LOT 2 PCS.			
100x70	MA-100x70	109,02	129,75
100x75	MA-100x75	101,30	120,86
100x80	MA-100x80	76,42	91,24
100x87	MA-100x87	48,59	58,07
110x21	MA-110x21	216,84	260,10
110x27	MA-110x27	207,36	251,32
110x30	MA-110x30	205,59	246,46
110x40	MA-110x40	197,89	237,58
110x50	MA-110x50	187,22	224,55
110x60	MA-110x60	169,44	203,21
110x70	MA-110x70	140,70	168,84
110x80	MA-110x80	121,45	145,74
110x90	MA-110x90	100,71	120,27
110x100	MA-110x100	100,71	120,27
120x21	MA-120x21	253,10	271,01
120x30	MA-120x30	237,40	284,97
120x40	MA-120x40	228,10	277,88
120x50	MA-120x50	218,61	262,46
120x60	MA-120x60	200,85	244,10
120x70	MA-120x70	187,22	229,87
120x80	MA-120x80	156,41	196,71
120x90	MA-120x90	125,61	150,48
120x100	MA-120x100	100,48	120,86
125x29	MA-125x29	261,27	314,02
125x30	MA-125x30	260,69	312,24
125x31	MA-125x31	259,49	311,05
125x32	MA-125x32	259,49	311,05
125x34	MA-125x34	257,72	309,26
125x35	MA-125x35	256,25	308,07
125x36	MA-125x36	254,35	305,71
125x39	MA-125x39	246,18	293,87
125x40	MA-125x40	244,92	290,90
125x42	MA-125x42	241,94	289,12
125x43	MA-125x43	242,43	287,95
125x44	MA-125x44	241,79	286,17
125x46	MA-125x46	240,60	280,23
125x48	MA-125x48	236,39	277,28
125x50	MA-125x50	227,51	272,53
125x54	MA-125x54	223,95	269,58
125x56	MA-125x56	221,59	265,43
125x58	MA-125x58	216,84	260,69
125x60	MA-125x60	207,36	250,01
125x65	MA-125x65	206,18	248,24
125x70	MA-125x70	193,74	232,24
125x75	MA-125x75	183,07	219,80
125x80	MA-125x80	172,40	207,36
125x90	MA-125x90	160,55	192,56
PRICE LIST 2015			
PAG. 30			

Diameter	Code	ADIPOL Price €	ULTRAFLEX Price €
MINIMUM LOT 2 PCS.			
125x100	MA-125x100	112,58	135,66
125x110	MA-125x110	91,84	109,02
130x27	MA-130x27	302,33	362,48
130x30	MA-130x30	291,48	350,15
130x39	MA-130x39	279,64	335,93
130x40	MA-130x40	277,87	334,74
130x50	MA-130x50	263,65	316,37
130x54	MA-130x54	254,16	305,11
130x60	MA-130x60	235,20	282,61
130x70	MA-130x70	219,21	263,05
130x80	MA-130x80	202,84	244,10
130x90	MA-130x90	170,63	223,36
130x100	MA-130x100	131,53	175,37
130x110	MA-130x110	103,09	123,83
140x27	MA-140x27	330,60	396,37
140x30	MA-140x30	327,04	391,62
140x40	MA-140x40	314,60	377,40
140x50	MA-140x50	300,38	359,63
140x60	MA-140x60	280,23	335,93
140x70	MA-140x70	257,12	308,68
140x80	MA-140x80	232,24	277,87
140x90	MA-140x90	202,62	243,51
140x100	MA-140x100	191,96	230,47
140x110	MA-140x110	158,78	190,78
140x120	MA-140x120	109,02	130,34
150x30	MA-150x30	365,55	437,83
150x40	MA-150x40	354,19	431,91
150x50	MA-150x50	353,10	423,03
150x60	MA-150x60	329,70	395,18
150x65	MA-150x65	319,64	382,73
150x70	MA-150x70	309,86	372,07
150x80	MA-150x80	282,61	338,89
150x90	MA-150x90	254,35	305,11
150x100	MA-150x100	234,03	246,82
150x110	MA-150x110	204,40	245,87
150x120	MA-150x120	158,19	189,59
150x130	MA-150x130	119,68	187,81
160x27	MA-160x27	422,43	507,15
160x30	MA-160x30	420,06	504,18
160x36	MA-160x36	412,95	495,90
160x40	MA-160x40	406,43	488,59
160x50	MA-160x50	393,40	472,20
160x60	MA-160x60	373,85	449,10
160x65	MA-160x65	363,18	436,65
160x70	MA-160x70	352,52	424,20
160x80	MA-160x80	338,89	407,02
PRICE LIST 2015			
PAG. 31			



A.E.M. S.r.l. Di Rota & C.
 41122 MODENA - (Italy)
 Via Papa Giovanni XXIII, 7
 Tel. 059.25.05.64 - Fax 059.25.00.28
 Sito Internet: www.aemsrl.it
 E-mail: Info@aemsrl.it

Reg. Soc. Tribunale di Modena n° 9174
 R.E.A. Di Modena n° 170278
 Cap. Soc. 50.000€ i.v.
 Cod. Fisc. e Partita I.V.A. N. 00507030369
 Codice Intra UE VAT nr. IT 00507030369

POLIURETANO COMPATTO DI QUALITÀ ADIPOL - ULTRAFLEX - POLIFLEX

CUSHIONING DISCS ADIPOL / ULTRAFLEX

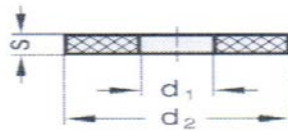

NET PRICES

Lot of 10 pcs.

D1	D2	S	ADIPOL Price €	ULTRAFLEX Price €
10,5	15	4	€ 1,07	€ 1,34
6,4	16	3	€ 1,05	€ 1,31
11	17	3	€ 1,09	€ 1,37
13	19	4	€ 1,12	€ 1,41
8,5	20	3	€ 1,09	€ 1,37
14	23	4	€ 1,16	€ 1,45
15,5	23	4	€ 1,19	€ 1,48
12	24	5	€ 1,16	€ 1,45
10,5	25	4	€ 1,16	€ 1,45
13	25	4	€ 1,16	€ 1,45
14	26	5	€ 1,22	€ 1,52
17	26	4	€ 1,22	€ 1,52
18	27	4	€ 1,56	€ 1,95
22	28	6	€ 1,34	€ 1,68
21	30	5	€ 1,58	€ 1,97
13,5	32	4	€ 1,58	€ 1,97
25	32	6	€ 1,63	€ 2,04
18	32	7	€ 1,63	€ 2,04
23,5	34	4	€ 1,92	€ 2,40
21	35	7	€ 1,92	€ 2,40
26	35	6	€ 1,76	€ 2,21
21	36	5	€ 1,98	€ 2,48
17	38	5	€ 2,02	€ 2,52
21	38	6	€ 2,13	€ 2,67
13,5	40	5	€ 1,76	€ 2,21
32	40	6	€ 1,84	€ 2,30
27	41	7	€ 2,19	€ 2,74



D1	D2	S	ADIPOL Price €	ULTRAFLEX Price €
31	42	6	€ 2,02	€ 2,52
37	46	6	€ 2,49	€ 3,11
32	49	8	€ 3,10	€ 3,87
17	50	6	€ 2,36	€ 2,95
26	50	6	€ 3,10	€ 3,87
37	53	8	€ 3,42	€ 4,28
32	60	10	€ 6,59	€ 8,24
17	63	6	€ 3,66	€ 4,58
37	65	10	€ 6,59	€ 8,24
42	70	10	€ 7,47	€ 9,33
21	80	10	€ 9,57	€ 11,96
21	100	10	€ 12,22	€ 15,28
27	125	10	€ 18,31	€ 22,89

